

SUGGESTED BOARD LAY OUT
TOP VIEW

NOTES:
 1-ALL DIMENSIONS IN MILLIMETERS
 2-DIMENSIONS TOLERANCES +/- 0.05MM UNLESS SPECIFIED



CONTECH SOLUTIONS INC.

FOOTPRINT DRAWING FOR 68 PINS 0.40MM PITCH DEVICE
 P#CSLGA68-0.4-030-FYRSTI

DRAWN BY: V.-MOJICA	SCALE: DO NOT SCALE	REV#: --/--/--	DATE 08/11/06
DRWG # 08-06-0013		TYPE -/-	

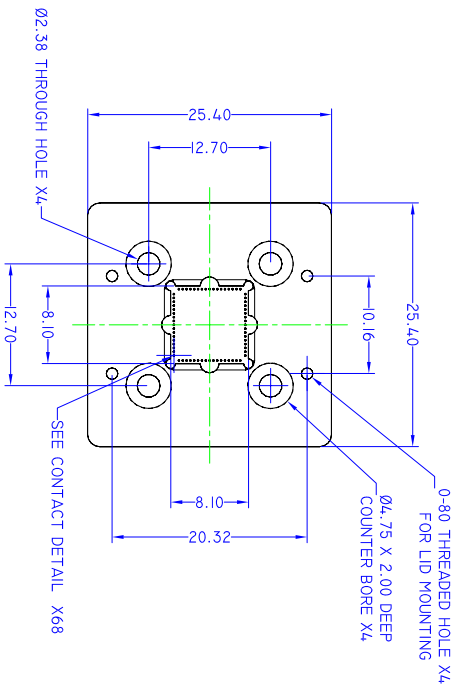

TOP VIEW

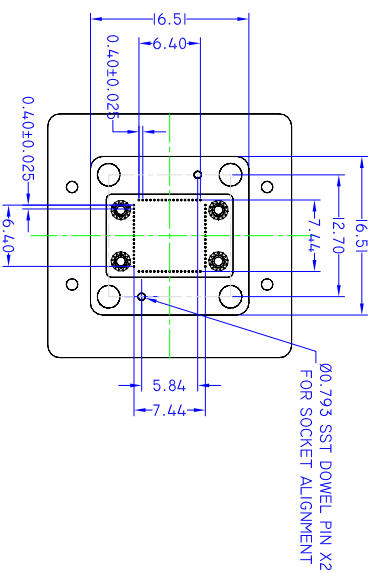

BOTTOM VIEW

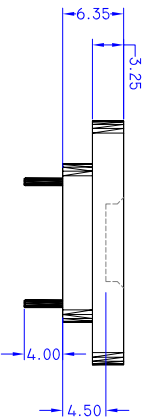

- NOTES:
- 1-CONTACT B2503 PLUGER(2 REOD) : GOLD PLATED HARD STEEL.
 - 2-SPRING : GOLD PLATED STAINLESS STEEL.
 - 3-BARREL : GOLD PLATED HARD BF-CU
 - 4-FORCE: 27g PER CONTACT AT OPERATING HEIGHT.
 - 5-ALL DIMENSIONS ARE IN MILLIMETERS.
 - 6-ALL TOLERANCES +/- 0.05 UNLESS SPECIFIED.

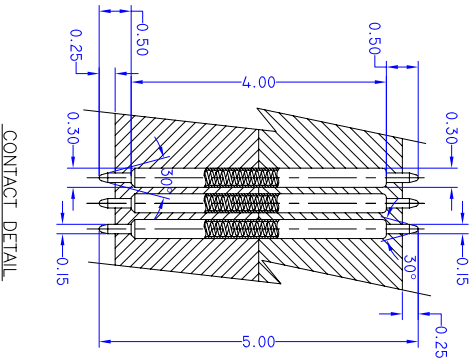

CONTECH SOLUTIONS INC.

CUSTOM TEST SOCKET FOR 68 PINS 0.40MM PITCH DEVICE

P#CSSLGA68-0-L-030-FYRSTI

DRAWN BY: V.-MOJICA
SCALE: DO NOT SCALE

DATE: 08/11/06
REV#--/--/--
TYPE: -/-

DRWG # 08-06-0014

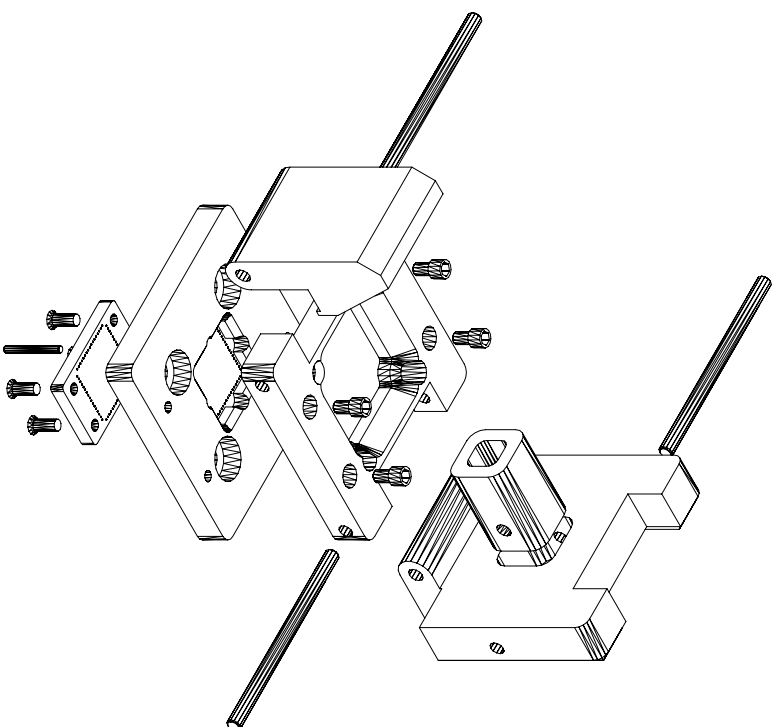

CONTECH SOLUTIONS INC.

CUSTOM TEST SOCKET FOR 68 PINS 0.40MM PITCH DEVICE
 P#CSLGA68-0.4-030+FYRSTII

DRAWN BY: V.-MOJICA
 SCALE: DO NOT SCALE

DRWG # 08-06-0016
 DATE 08/11/06
 REV#-- --/---/--
 TYPE -/-



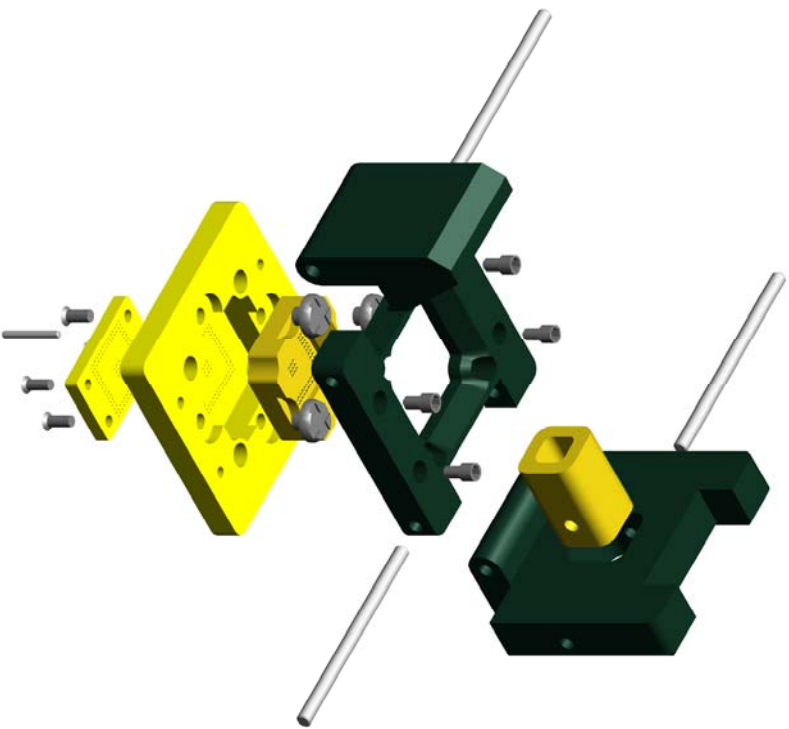

CONTECH SOLUTIONS INC.

CUSTOM TEST SOCKET FOR 68 PINS 0.40MM PITCH DEVICE
 P#CSLGA68-0.4-030-FYRST1

DRAWN BY: V.-MOJICA
 SCALE: DO NOT SCALE

DRWG # 08-06-0017
 DATE 08/11/06
 REV# --/---/--
 TYPE -/-

